

## Operator's Instruction Manual

# HSS-14



NOTE: Shown with optional cart

## 14" Gasoline Powered Masonry Saw

### Manual - Portable

## READ AND UNDERSTAND THE OPERATORS INSTRUCTION MANUAL THOROUGHLY BEFORE ATTEMPTING TO OPERATE THIS EQUIPMENT.



**Death or serious injury could occur if this machine is used improperly.**



### SAFETY MESSAGES

- Safety Instructions are preceded by a graphic alert symbol of DANGER, WARNING, or CAUTION.

#### DANGER

Indicates an imminent hazard which, if not avoided, will result in death or serious injury.

#### WARNING

Indicates an imminent hazard which, if not avoided, can result in death or serious injury.

#### CAUTION

Indicates hazards which, if not avoided, could result in serious injury and or damage to the equipment.

### GASOLINE/PROPANE POWERED EQUIPMENT

#### WARNING

- Engine exhaust from this product contains chemicals known to the State of California to cause cancer, birth defects or other reproductive harm.



- Gasoline is extremely flammable and poisonous. It should only be dispensed in well ventilated areas, and with a cool engine.

- Small gasoline engines produce high concentrations of carbon monoxide (CO) example: a 5 HP 4 cycle engine operation in an enclosed 100,000 cu. ft. area with only one change of air per hour is capable of providing deadly concentrations of CO in less than fifteen minutes. Five changes of air in the same area will produce noxious fumes in less than 30 minutes. Gasoline or propane powered equipment should not be used in enclosed or partially enclosed areas. Symptoms of CO poisoning include, headache, nausea, weakness, dizziness, visual problems and loss of consciousness. If symptoms occur - get into fresh air and seek medical attention immediately.

### ELECTRICAL POWERED EQUIPMENT



Extreme care must be taken when operating electric models with water present: Ensure power cord is properly grounded, is attached to a Ground-Fault-Interrupter (GFI) outlet, and is undamaged.

- Check all electrical cables - be sure connections are tight and cable is continuous and in good condition. Be sure cable is correctly rated for both the operating current and voltage of this equipment.
- Improper connection of the equipment-grounding conductor can result in a risk of electric shock. Check with qualified electrician or service person if there is any doubt as to whether the outlet is properly grounded. Adhere to all local codes and ordinances.
- **NOTE:** In the event of a malfunction or breakdown, grounding provides a path of least resistance for the electric current to dissipate. The motor is equipped with a grounded plug and must be connected to an outlet that is properly installed and properly grounded. DO NOT modify the plug provided on the motor. If the plug does not fit the outlet have a qualified electrician install the proper receptacle.
- Switch motor OFF **before** disconnecting power.

- Do not disconnect power by pulling cord. To disconnect, grasp the plug, not the cord.
- Unplug power cord at the machine when not in use and before servicing.

### GENERAL INSTRUCTIONS

- Equipment should only be operated by trained personnel in good physical condition and mental health (not fatigued). The operator and maintenance personnel must be physically able to handle the bulk weight and power of this equipment.
- This is a one person tool. Maintain a safe operating distance to other personnel. It is the **operator's responsibility** to keep other people (workers, pedestrians, bystanders, etc.) away during operation. Block off the work area in all directions with roping, safety netting, etc. for a safe distance. Failure to do so may result in others being injured by flying debris or exposing them to harmful dust and noise.
- This equipment is intended for commercial use only.
- For the operator's safety and the safety of others, always keep all guards in place during operation.
- Never let equipment run unattended.



- Personal Protection Equipment and proper safety attire must be worn when operating this machinery. The operator must wear approved safety equipment appropriate for the job such as hard hat and safety shoes when conditions require. Hearing protection MUST be used (operational noise levels of this equipment may exceed 85db). Eye protection MUST be worn at all times.



Keep body parts and loose clothing away from moving parts. Failure to do so could result in dismemberment or death.

- Do not modify the machine.
- Stop motor/engine when adjusting or servicing this equipment.



Maintain a safe operating distance from flammable materials. Sparks from the cutting-action of this machine can ignite flammable materials or vapors.

### DUST WARNING

#### WARNING

Some dust created by power sanding, sawing, grinding, drilling, and other construction activities contains chemicals known to cause cancer, birth defects, or other reproductive harm. Some examples of these chemicals are:

- Lead from lead-based paints, and
- Crystalline silica from bricks and concrete and other masonry products.

Your risk of exposure to these chemicals varies depending on how often you do this type of work. To reduce your risk: work in a well ventilated area, use a dust control system, such as an industrial-style vacuum, and wear approved personal safety equipment, such as a dust/particle respirator designed to filter out microscopic particles.

# SPECIFICATIONS

<u>Section</u>	<u>Page Number</u>
Safety/Warnings.....	2
Specifications/Table of Contents.....	3
Safety Guidelines.....	4
Operating Instructions.....	5
Before Starting Engine.....	6
Laser Instructions.....	6
Starting the Engine.....	7
Cutting.....	7
Maintenance.....	8-10
SMI Dust and Silica Warning.....	10
Maintenance Schedule.....	11
Limited Equipment Warranty.....	Back Page

Note:  
All dimensions and weights are for **reference only** and subject to change at any time.

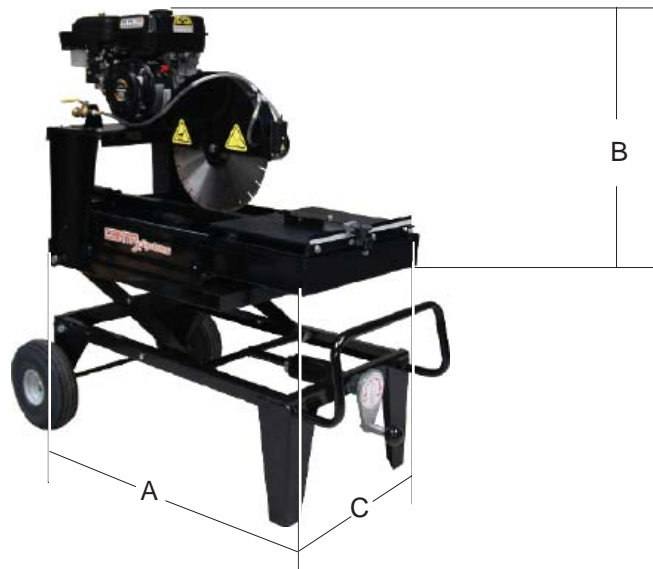

**Figure 1**

### HOW TO ORDER REPAIR PARTS

To insure product safety and reliability, always use genuine CONTRx replacement parts when making repairs to the equipment.

When ordering parts, please specify the MODEL and SERIAL NUMBER of the machine as given on the NAMEPLATE. In addition, give part number, description and quantity as listed on the parts list.

Please note: Due to improvements and changes in the equipment the illustrations shown may be different from the actual machine.

Toll Free: Phone 1-800-638-3326 • Fax 1-800-447-3326

	HSS-14
"A"	42" 106.68cm
"B"	27" 65.58cm
"C"	20" 50.8cm
--	--
--	--
Weight	208 lbs. 94.3kg



Read and understand this *Operator's Instruction Manual*,  
and the *Engine Manufacturer's Owner's Manual*  
**before** operating this equipment.



Death of serious injury can result if this machine is used improperly.



## Safety Guidelines



Eye and ear protection must be worn at all times while the HSS-14 is in use. During normal operation, sound pressure levels exceed 85dBA. Use only ANSI approved safety glasses to help prevent eye injury. Everyday eyeglasses have only impact resistant lenses; they are NOT safety glasses.



Operator must wear appropriate clothing and footwear. Do not wear loose clothing or jewelry that can get tangled in moving parts. Footwear should provide sure footing and protection from debris that may be dropped. Take steps to be sure hair will not be caught in moving parts. If necessary, tie it back.



Disconnect the spark plug wire lead before performing any service on the machine.

- When loading or unloading the saw, use caution. Make sure rolling table is locked using the table lock so that the blade will not be damaged. (Figure 4, Item K) Do not move the saw while the engine is running.
- This unit is shipped new from the factory without oil or gasoline, it will need to be added before it is used. Check the *Engine Manufacturer's Owner's Manual* for instructions on break-in, servicing and use of engine.



This HSS-14 gasoline powered saw is designed to be used in areas where electrical power is not available. Do not operate gasoline-powered equipment without adequate ventilation. The exhaust fumes contain carbon monoxide, an invisible, odorless gas that can kill.



This machine is designed to cut brick, pavers, stone and tile. The work piece must be placed on the rolling table surface and the table used to move the work piece to the blade. Cut only in a straight line. Do not force or twist the work piece into the blade. Personal injury or damage to the equipment or blade can result.

- Never exceed the maximum operating speed of the blade. Match the blade speed rating with the arbor shaft speed.
- Never leave the saw running unattended.
- Never operate this saw under the influence of drugs, alcohol or when taking medications that impair the senses or reactions, or when excessively tired or under stress.
- Make sure all safety decals can be clearly read and understood. Replace damaged or missing decals immediately.

Safety warnings and guidelines do not by themselves eliminate danger.

They are not given as substitutes for proper accident prevention procedures and good judgement.

# Operating Instructions

Diagrams shown with Honda Cyclone Dual-Filter Element Engine as an example. Consult the *Engine Manufacturer's Owner's Manual* for information on specific models.

- A. Spark Plug Lead
- B. Air Filter
- C. Vacuum Hook Up
- D. Water Tray
- E. Oil Drain
- F. Oil Plug/Dip Stick
- G. Engine Throttle
- H. Fuel Valve Lever
- I. Choke
- J. Air Filter Housing
- K. Table Lock
- L. Back Stop
- M. Right Angle Guide Bar

- N. Rolling Table
- O. Diamond Blade
- P. Blade Guard
- Q. Water Hose
- R. On/Off Switch
- S. Recoil Starter
- T. Fuel Tank
- U. Muffler
- V. Belt Guard
- W. Dust Channel
- X. Drain Plug
- Y. (Optional) Cart
- Z. Lazer Cutting Guide Light

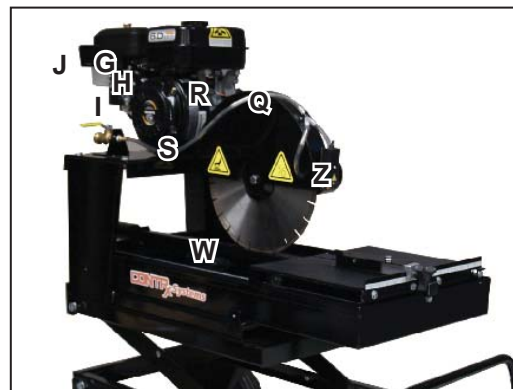

Figure 3

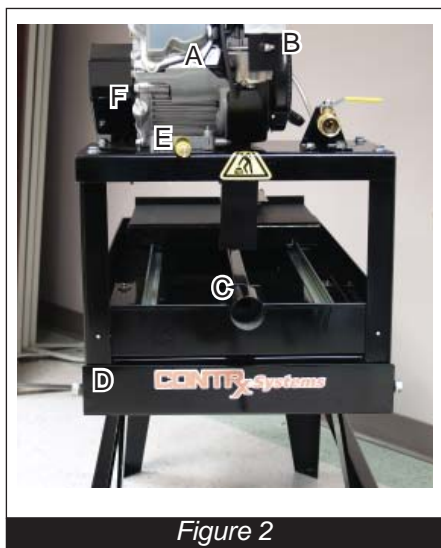

Figure 2



Figure 4

**Before Starting Engine:**

- Read and understand the instructions supplied by the engine manufacturer.
- Familiarize yourself with all engine and saw controls.
- Visually inspect the entire machine for damage or wear. Look for signs of oil or fuel leaks. Remove excess dirt or debris. Check that all nuts, bolts and screws are tightened. Check for proper alignment of moving parts, possible binding of moving parts, breakage of parts, loose mounting brackets, and any other condition that might affect operation.
- Inspect diamond blade and arbor shaft. Check blades for cracks, loose segments, worn or out-of-round arbor holes. Do not use warped, twisted, out-of-balance blades or any blade of questionable condition. (Figure 9)
- Check engine oil. Make sure that it is at the proper level and that it is clean.  
**Note:** Some engines have an Oil Alert System that will automatically stop the engine before the oil level falls below the safe limit. To avoid an unexpected shut down, check the oil level regularly during operation.
- Check the fuel level. Do not over fill fuel tank and never refuel a hot engine. If refueling is necessary during operation, allow engine to cool down first.
- Inspect the air filter to be sure it is clean.
- If wet cutting, attach water source to the machine's supply hose circled in (Figure 5). If you have a place for the water to run, remove the drain plug in the water tray (Figure 6).
- If wet cutting with the optional water pump which recycles the water from the tray, plug the drain hole and be sure the water is circulating from the tray to the water pump.
- If dry cutting, attach the vacuum to the end of the dust channel circled in (Figure 7).  
**Note:** While the HSS-14 was designed to be used with a standard shop vac, CONTRx recommends using a heavy duty industrial vacuum such as the VAC-100. The VAC-100 has the advantage of a Self-Purging System to help keep concrete dust from building up on the filter and a larger filter area to maintain performance during use. Thus, reducing time wasted on frequently cleaning a standard shop vac and filter media.

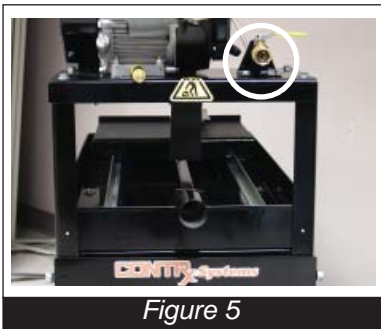

Figure 5



Figure 6

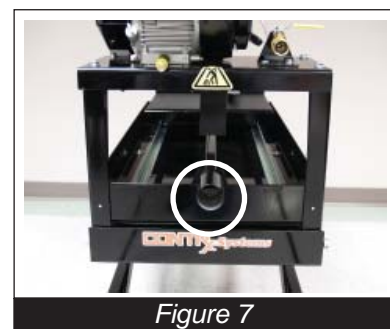

Figure 7

**Laser Instructions:**

- Caution, this saw is equipped with a LASER cutting guide. To turn on flip the switch located on top of the unit to the left. Be sure to turn off when not in use to keep from draining the batteries (2 ea. AAA batteries). To replace batteries, remove the one screw above the warning label, remove the cover to replace the batteries. Reverse the procedure to reassemble. The LASER guide does not work well in bright sun light. Use in subdued light only for best results. Be sure to wear vision protection suitable for LASER technology.



- Be sure blade is clear of item to be cut.
- Determine that the recoil starter assembly turns freely, starter rope pulls easily, and the rope retracts properly.
- Follow the instructions supplied in the engine manufacturer's *Owner's Manual* for starting engine.
- Open the throttle and allow engine to reach operating temperature. Do not use the throttle as a means to match the specified blade speed to the arbor shaft speed. **Note:** To ensure the necessary power is transferred to the blade, all cutting must be done at *full throttle*. The governor is factory set for correct speed - altering this setting will damage the machine. Maintain engine to factory specifications.

**Cutting:**

- Place the work piece on rolling table against the backstop and use the rolling table to move the work piece to the blade. Do not strain the engine while cutting or jam work piece into the blade. Do not twist the work piece while cutting.
- Do not reach underneath or around work piece while the blade is rotating.
- Keep stable footing at all times while cutting.



Keep hair, clothing, fingers and all body parts away from the blade and any other moving parts.

- For wet cutting, maintain an adequate supply of water to cool the blade. **Note:** If using the optional water pump, clean water must be run through the cycle daily to avoid build up in the pump.
- When you have finished cutting, return throttle to idle. Stop the engine by returning the engine mounted stop switch to the OFF position. Do not leave the saw running unattended.
- Clean dust and debris from whole machine - including inside the dust channel.

Use Diamond Blades Only	
Blade Diameter	14 inches
Arbor Shaft Diameter	1.0 inches
Max Cutting Depth	4 1/2 inches
Arbor Speed	3600 RPM

Figure 8

Refer to the *Rx for Diamond Blades* for more detailed information on diamond blades.

**IMPORTANT REMINDER:** This machine is designed to use diamond blades to cut pavers, stone, tile, masonry products and brick. Do not use it to cut anything else.

## Possible Diamond Blade Problems

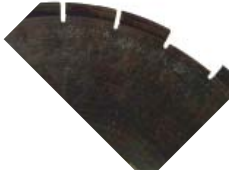

**Segment Loss:**  
Usually insufficient water



**Arbor Hole Out-Of-Round**  
Blade not properly tightened or seated on arbor.



**Cracked Segments and/or Core**  
Wrong Blade for the job.

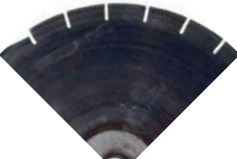

**Blade Will Not Cut:**  
Blade is glazed or too hard for the job.

Figure 9

**WARNING**

**Disconnect spark plug lead before performing any maintenance on this machine.**

**WARNING**

## Maintenance

Consult the *Engine Manufacturer's Owner's Manual* for more detailed engine maintenance instructions.

### Changing the Blade:

- Inspect the new blade thoroughly before installing. Check for cracks, loose segments, worn or out-of-round arbor holes. Refer to the *Rx for Diamond Blades* pamphlet provided with your blade for more detailed information on inspecting blades. Be sure the blade is appropriate for the job and matches the arbor shaft speed & mounting configuration on this saw. (See page 11)

The HSS-14 was designed to be used with diamond saw blades only. It is a "fixed head machine", therefore it is important to use blades that will not wear down. Fiber blades will wear down and the cut will not go all the way through the work piece. In addition, for the vacuum system to operate properly when dry cutting, the blade must reach into the dust channel.



Figure 10

#### **Step One:**

Move the rolling table out of the way to the back or front of the machine.

Loosen the two wing nuts on the back side of the blade guard and rotate blade guard back and tighten to hold in guard in place. (Figure 10)

#### **Step Two:**

Loosen and remove arbor cap bolt. (Figure 11)

Carefully remove old blade. Inspect arbor shaft, backing plate and blade guard while blade is off. Clean if dirty or replace if damaged or worn.



Figure 11

#### **Step Three:**

Look for "direction of rotation" markings on the new blade. (Usually an arrow stamped on the blade.)

Place new blade on the arbor shaft verifying that the markings on the blade follow the proper direction of rotation. Blade should be positioned in the center of the dust channel. (Figure 12)

Reinstall and tighten bolt using a SAE 3/4" wrench.

Reposition blade guard and tighten wing nuts.

Reconnect spark plug lead.



Figure 12

## **Belt Adjustment and Replacement:**

- Periodically check to be sure the belts are undamaged and that they are at the proper tension. Slipping belts will overheat causing the cutting speed to be limited and will shorten the life of the belts. Over-tensioned belts will shorten the life of the belts and bearings.
- On new equipment and after installing new belts, be certain to re-tension the belts after the first 4 hours of use. New belts are stiff and require a break in period. Belts that become loose could slip and/or overheat.
- Damaged, stretched or excessively worn belts should be replaced with a new complete set of belts.

**IMPORTANT:** Belts must be replaced as a set, even if only one belt is showing wear.

- Remove belt guard (3 bolts) and inspect belts. A straight edge is a good tool to use to be certain sheaves are even and properly aligned. (*Figure 13*)
- To tension/loosen belts or to remove worn belts, loosen engine mounting bolts (4) and slide the engine forward or back until belts are at proper tension or loose enough to remove. (*Figure 14*)
- To remove belts, loosen engine mounting bolts (4) and jacking screw (circled) to allow the engine to slide forward until belts slide off of the sheaves. (*Figure 14*)
- Place a complete set of new belts on the machine. Reposition engine then tighten bolts. Reinstall belt cover.



Figure 13

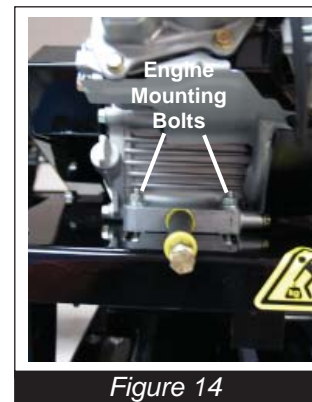

Figure 14



Figure 15

## **Clean and Lubricate Wheels on Rolling Table:**

During daily visual inspection, check to be sure the wheels on the rolling table move smoothly and that there is no debris in the wheel tracks. (*Figure 15*)

Lubricate the wheels as necessary. Replace damaged or worn wheels circled in (*Figure 15*).

**Change Engine Oil:**

- Check Engine Oil before each operation. Open the filler cap and look at the dip stick. (Figure 16)  
Oil should be clearly visible both on the stick and in the cavity and should look fairly clean. Running the machine on dirty oil or when the oil is low will result in damage to the equipment.
- Change the Engine Oil after every 50 hours of operation - or sooner as conditions require. Refer to the Engine Manufacturer's Owner's Manual for specific viscosity recommendations and changing instructions.

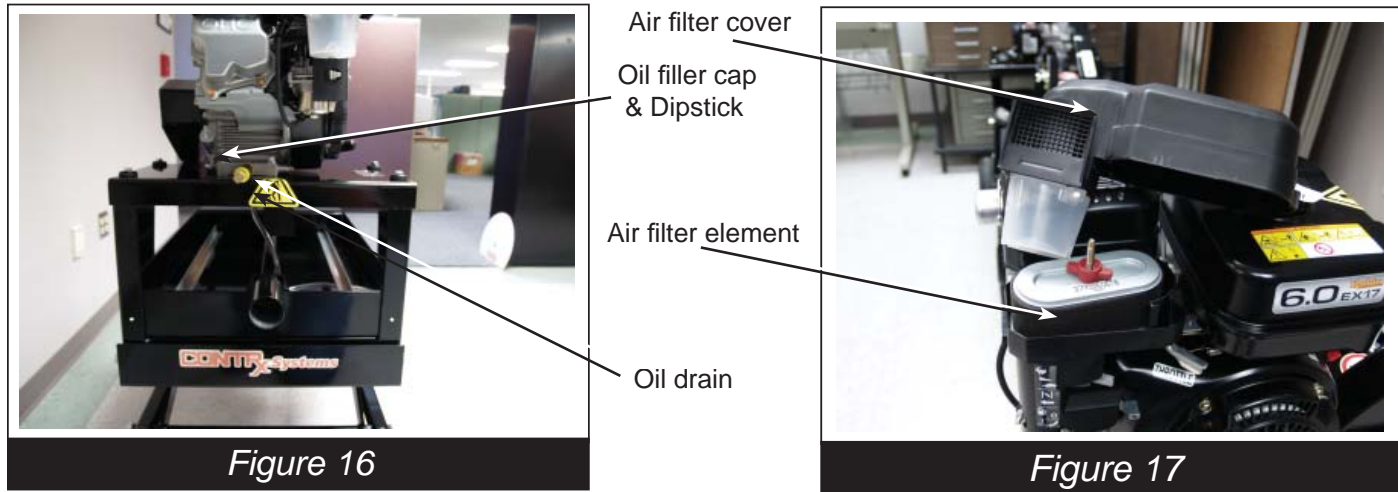

**NOTE:** To remove air filter cover remove wing nut on top of filter cover and lift cover off as shown in (Figure 17).

**Inspect and Clean Oil Air Filter:**

Shown with filter element. Outer foam filter is removable for cleaning. Refer to the Engine Manufacturer's Owner's Manual for instructions on specific models. Check air filter at least once daily. (Figure 17)  
Dirt build up on the filter will cause the engine to wear faster.

**SMI Dust and Silica Warning**

Grinding/cutting/drilling of masonry, concrete, metal and other materials can generate dust, mists and fumes containing chemicals known to cause serious or fatal injury or illness, such as respiratory disease, cancer, birth defects or other reproductive harm. If you are unfamiliar with the risks associated with the particular process and/or material being cut or the composition of the tool being used, review the material safety data sheets and/or consult your employer, the manufacturers/suppliers, governmental agencies such as OSHA and NIOSH and other sources on hazardous materials. California and some other authorities, for instance, have published lists of substances known to cause cancer, reproductive toxicity, or other harmful effects.

Control dust, mist and fumes at the source where possible. In this regard use good work practices and follow the recommendations of the manufacturers/suppliers, OSHA/NIOSH, and occupational and trade associations. Water should be used for dust suppression when wet grinding/cutting/drilling is feasible. When the hazards from inhalation of dust, mists and fumes cannot be eliminated, the operator and any bystanders should always wear a respirator approved by NIOSH/MSHA for the material being used.

Grinding/cutting/drilling of masonry, concrete and other materials with silica in their composition may give off dust or mists containing crystalline silica. Silica is a basic component of sand, quartz, brick clay, granite and numerous other minerals and rocks. Repeated and/or substantial inhalation of airborne crystalline silica can cause serious or fatal respiratory diseases, including silicosis. In addition, California and some other authorities have listed respirable crystalline silica as a substance known to cause cancer. When grinding/cutting/drilling such materials, always follow the respiratory precautions mentioned above.



Repairs are to be done by authorized CONTRx Dealers only.



Read and follow instructions in the Engine Manufacturer's Owner's Manual.

## Maintenance Schedule

This is for a quick reference to the information supplied in the Maintenance portion of this manual.

Follow the Engine Manufacturer's Maintenance Instructions	Before Operation	Daily	After Operation	Every 50 Hours of Operation	As Required	Annually
Visually Inspect Entire Machine and Hardware	X					
Check Engine Oil	X					
Inspect Blade and Arbor Shaft	X					
Inspect Guards		X				
Clean and Oil Air Filter		X				
Clean Dust and Dirt Off Machine			X			
Change Engine Oil				X		
Inspect Belts					X	
Lubricate Wheels on Rolling Table					X	
Replace Spark Plug						X

**LIMITED EQUIPMENT WARRANTY OF SALE – TERMS & CONDITIONS**

Equipment Development Company, Inc. herein referred to as EDCO (Seller) warrants that each new unit manufactured by EDCO to be free from defects in material and workmanship in normal use and service for a period of (1) one year (except for the cutter drum assembly on all model concrete/asphalt planes, in which case the warranty period shall be 90 days) from date of shipment to the original retail or equipment rental center owner.

Accessories or equipment furnished and installed on the product by EDCO but manufactured by others, including, but not limited to engines, motors, electrical components, transmissions etc., shall carry the accessory manufacturers own warranty.

EDCO will, at its option, repair or replace, at the EDCO factory or at a point designated by EDCO, any part which shall appear to the satisfaction of EDCO inspection to have been defective in material or workmanship.

EDCO reserves the right to modify, alter and improve any part or parts without incurring any obligation to replace any part or parts previously sold without such modified, altered or improved part or parts.

This warranty is in lieu of and excludes all other warranties, expressed, implied, statutory, or otherwise created under applicable law including, but not limited to the warranty of merchantability and the warranty of fitness for a particular purpose in no event shall seller or the manufacturer of the product be liable for special, incidental, or consequential damages, including loss of profits, whether or not caused by or resulting from the negligence of seller and/or the manufacturer of the product unless specifically provided herein. In addition, this warranty shall not apply to any products or portions thereof which have been subjected to abuse, misuse, improper installation, maintenance, or operation, electrical failure or abnormal conditions and to products which have been tampered with, altered, modified, repaired, reworked by anyone not approved by seller or used in any manner inconsistent with the provisions of the above or any instructions or specifications provided with or for the product

**FORCE MAJEURE**

Seller's obligation hereunder are subject to, and Seller shall not be held responsible for, any delay or failure to make delivery of all or any part of the Product due to labor difficulties, fires, casualties, accidents, acts of the elements, acts of God, transportation difficulties, delays by a common carrier, inability to obtain Product, materials or components or qualified labor sufficient to timely perform part of or all of the obligations contained in these terms and conditions, governmental regulations or actions, strikes, damage to or destruction in whole or part of manufacturing plant, riots, terrorist attacks or incidents, civil commotions, warlike conditions, flood, tidal waves, typhoon, hurricane, earthquake, lightning, explosion or any other causes, contingencies or circumstances within or without the United States not subject to the Seller's control which prevent or hinder the manufacture or delivery of the Products or make the fulfillment of these terms and conditions impracticable. In the event of the occurrence of any of the foregoing, at the option of Seller, Seller shall be excused from the performance under these Terms and Conditions, or the performance of the Seller shall be correspondingly extended.

This document sets forth the terms and conditions pursuant to which the purchaser ("Purchaser") will purchase and Equipment Development Co. Inc. ("Seller") will sell the products, accessories, attachments (collectively the Products) ordered by the Purchaser. These terms and conditions shall govern and apply to the sale of Seller's Products to Purchaser, regardless of any terms and conditions appearing on any purchase order or other forms submitted by Purchaser to Seller, or the inconsistency of any terms therein and herein.

**1. PRICE**

All prices set forth on any purchase order or other document are F.O.B. Sellers facility or distribution point, as may be determined by Seller (F.O.B. Point). All prices are exclusive of any and all taxes, including, but not limited to, excise, sales, use, property or transportation taxes related to the sale or use of the Products, now or hereafter imposed, together with all penalties and expenses. Purchaser shall be responsible for collecting and/or paying any and all such taxes, whether or not they are stated in any invoice for the Products. Unless otherwise specified herein, all prices are exclusive of inland transportation, freight, insurance and other costs and expenses relating to the shipment of the Products from the F.O.B. point to Purchaser's facility. Any prepayment by Seller of freight insurance and other costs shall be for the account of Purchaser and shall be repaid to Seller.

**2. PAYMENT TERMS**

Payment terms are as follows. 2% 10 days (to approved and qualified accounts). Net 30 days. This is a cash discount for invoices paid within 10 days after the invoice date, regardless of date of receipt of shipment. This is not a trade discount and will not be granted to accounts that do not adhere to stated terms.

\*All past due accounts are subject to a late payment fee of 1.5% per month or a maximum allowed by law if different, along with the expenses incidental to collection including reasonable attorney's fees and costs.

\*Seller reserves the right to hold shipments against past due accounts.

\*Seller reserves the right to alter payment terms.

**3. FREIGHT TERMS**

All shipments will be made F.O.B. shipping point as designated in these Terms and Conditions, and title shall pass at the F.O.B. point. Delivery to the initial common carrier shall constitute delivery to the Purchaser. Any claims for loss or damage during shipment are to be filed with carrier by the Purchaser. Seller will not assume responsibility for the performance of the carrier.

Back orders will be shipped in the most practical fashion with charges consistent with our freight policy established with the original order. UPS, FED EX, MAIL or shipments by other couriers are subject to the same terms and conditions as outlined in paragraph #3 "Freight Terms".

**4. DELIVERY, DAMAGES, SHORTAGES**

Seller shall use reasonable efforts to attempt to cause the Products to be delivered as provided for in these Terms & Conditions. Delivery to the initial common carrier shall constitute the delivery to the Purchaser. Seller's responsibility, in so far as transportation risks are concerned ceases upon the delivery of the Products in good condition to such carrier at the F.O.B. point and all the Products shall be shipped at the Purchaser's risk. Seller shall not be responsible or liable for any loss of income and/or profits, or incidental, special, consequential damages resulting from Seller's delayed performance in shipment and delivery.

**5. RETURN OF DEFECTIVE PRODUCTS**

Defective or failed material shall be held at the Purchaser's premises until authorization has been granted by Seller to return or dispose of Products. Products that are to be returned for final inspection must be returned Freight Prepaid in the most economical way. Credit will be issued for material found to be defective upon Seller's inspection based on prices at time of purchase.

**6. PRODUCTS ORDERED IN ERROR**

Products may be returned, provided that claim is made and Seller is notified within 7 days of receipt of Products, and the Products are in original buyer's possession not more than 30 days prior to return, subject to Seller's approval. If Products are accepted for return, they must be Freight Prepaid and buyer will be charged a minimum of 15% rehandling charge, plus a charge back for outbound freight charges if the original order was shipped prepaid. Returns are not accepted for any Products that are specifically manufactured to meet the buyer's requirement of either specifications or quantity.

**AGREEMENTS**

These Terms and Conditions constitute the entire agreement between Seller and Purchaser as it relates to terms and conditions of sale, and supersedes any and all prior oral or written agreements, correspondence, quotations or understandings heretofore in force between the parties relating to the subject matter hereof. There are no agreements between Seller and Purchaser with respect to the Product herein except those specifically set forth in and made part of these terms and conditions. Any additional terms, conditions and/or prices are rejected by Seller.

These terms and conditions may be modified, cancelled or rescinded only by a written agreement of both parties executed by their duly authorized agents.

**USE ONLY GENUINE EDCO PARTS & ACCESSORIES**  
**For your own safety, the safety of others and the life of your machine.**